

SHELBY

ACCESSORIES



ONE DOLLAR

Shelby Accessories

from the
man behind
the Cobra
— for the
man behind
the wheel



To members of the racing fraternity, the name Shelby needs no introduction. From Le Mans to Riverside, Watkins Glen to the Nurburgring, the tall Texan in the Striped Bib Overalls is a living legend.

Winner of more races than anyone can remember, including the 24 Hours of Le Mans... named "Driver of the Year" by Sports Illustrated... creator of the Cobra... mastermind of the racing team that took World Manufacturers Championships in 1965, 1966 and 1967, Carroll Shelby, his boots and his black cowboy hat, has been a familiar sight on victory row for more than a decade.

Associated with Ford Motor Company in recent years, Shelby produced the first Mustang based GT 350 in 1965, the GT 500 in 1967. The Shelby-prepared Mark II Ford became the first American car in history to win Le Mans—in 1966. In 1967, the Shelby team repeated the victory with the Ford Mark IV.

Now Carroll Shelby has put his experience and talent behind a full line of accessories for the car enthusiast. In this catalogue you'll find exclusive gift items designed especially for Shelby Accessories, articles of apparel for the well-turned out racer or enthusiast, plus high-performance equipment for Ford-produced cars. Only the finest quality accessories or apparel are included. Because every product must earn the right to wear the Shelby label. Your order will be computer-handled with speed and care that assures fast processing and careful shipping.

We wish you many happy moments of drifting through the pages of this catalogue. There are no wrong turns. Shelby Accessories, like the Shelby legend, is a world of winners.



Just after the car's return to this country, Carroll Shelby was pictured beside the winning Mark IV he prepared for the 1967 LeMans 24 hour endurance race. Team drivers for the car were Dan Gurney and A. J. Foyt.



Since his retirement as a driver, Carroll Shelby has subsequently become one of the world's leading manufacturers of racing cars. This has enabled him to surround himself with the best drivers the racing world has to offer.



The Cobra Story. A must for you car buffs who want to know the real behind the scene story of Carroll Shelby, the man, his dreams and his cars. \$3.95.

patches and decals

Jacket patches are Swiss embroidered of the finest threads and materials available.

All patches are washable and maintain their vivid colors wash after wash.

- A Cobra on Wheels..... \$1.50
- B Cobra Square..... \$1.50
- C Mustang..... \$1.00
- D Mach I..... \$1.50
- E Cougar..... \$1.00
- F Shelby (CS)..... \$1.00
- G Cobra Round, Gold. . . \$1.00
- H Cobra, Black & White,
3 x 14"..... \$2.00



Decals can be adhered to any clean flat surface.

- A Mach I..... \$.25
- B Cobra, Gold..... \$.25
- C Cobra on Wheels..... \$.25
- D Shelby Cams..... \$.25
- E Shelby (CS)..... \$.25



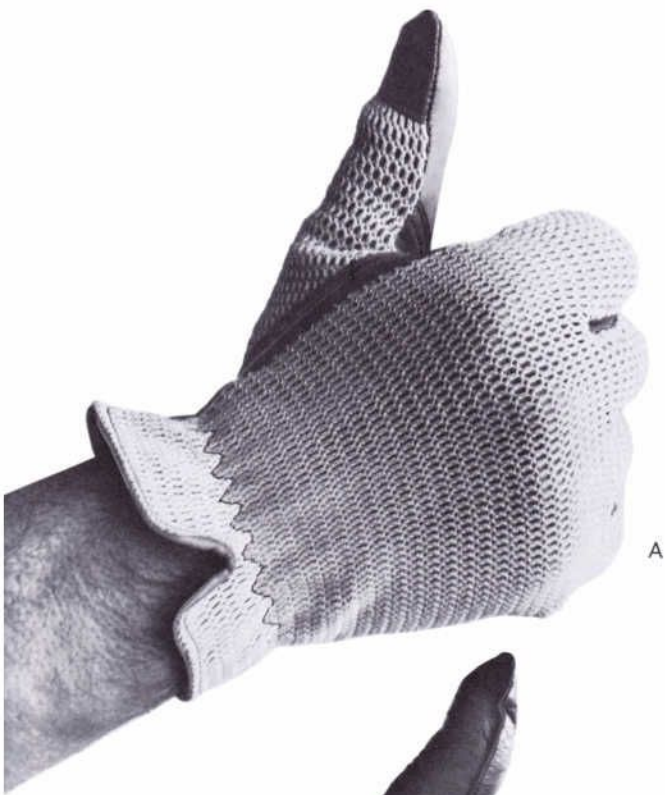

A



B



C

cobra driving gloves

Provides warmth, styling and positive traction on steering wheel while driving. Made of the finest quality ultra-soft English leather.

A Shelby Driving Gloves. Your choice of black or tan leather with knit back. Designed with your driving comfort in mind. Men's sizes 7 to 10. Women's size 7. \$8.50. Specify black or tan leather when ordering.

B Black leather. Ventilated open back gives added flexibility and comfort. Adjustable Velcro fastenings at wrist. Men's sizes 7 to 11. Women's sizes 6½ to 7½. \$8.95.

C Mexican Tan and Black Leather. All capeskin with Velcro fastenings at wrist. Men's sizes 7 to 11. Women's sizes 6½ to 7½. \$8.95.

Leather Grained Shift Knobs

These knobs fit all Ford or Ford Division produced cars with 3 or 4 speed stick shift. Available with Cobra, Mustang or Cougar insert. Specify 3 or 4 speed, make, model and year of car and emblem desired... \$4.95.



Walnut Shift Knobs

These top quality knobs fit all Ford or Ford Division produced cars with 3 or 4 speed stick shift. Available with Cobra, Mustang or Cougar insert. Specify 3 or 4 speed, make, model and year of car and emblem desired ... \$3.75.

Also available in plain walnut without emblem... \$3.75.



Walnut T-Bar

Center section is a one piece die casting with triple chrome plate. Comes complete with a special lock-out button. Installs in minutes on all Ford or Ford Division produced cars with floor mounted automatic shift. Specify make, model and year of car and emblem desired... \$5.95.

Also available in plain walnut without emblem... \$4.95.



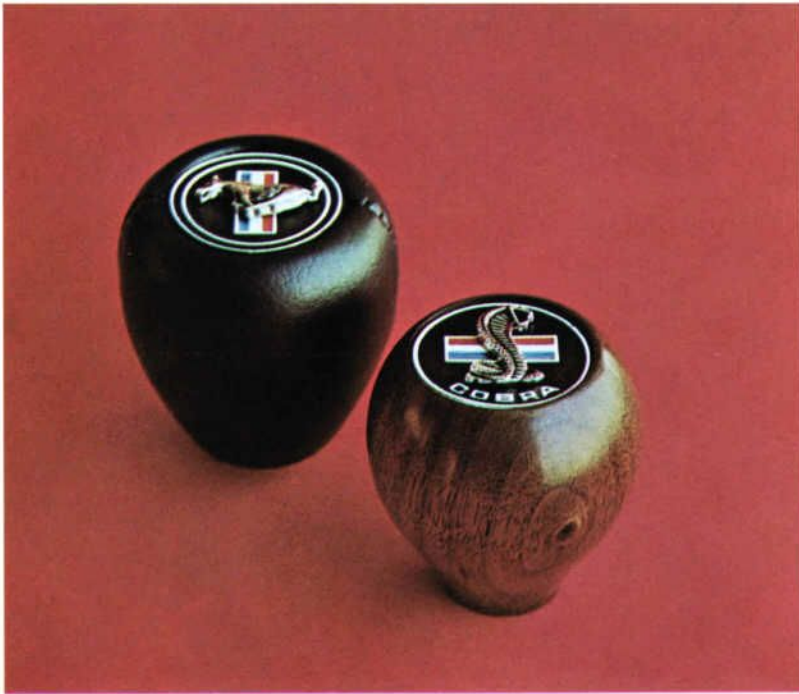

Leather Grained Shift Knob

This newly designed shift knob is constructed of the finest quality durable vinyl available. The vinyl is mounted on solid walnut and capped with either a Cobra, Mustang or Cougar insert. They fit all Ford or Ford Division produced cars with 3 or 4 speed stick shift. Specify 3 or 4 speeds, make, model and year of car and emblem desired. \$4.95.

Walnut Shift Knobs

These attractive knobs are made of solid walnut and are individually hand rubbed to bring out the natural grain of this most unusual wood. Available with the Cobra, Mustang or Cougar insert. Fits all Ford or Ford Division produced cars with 3 or 4 speed stick shift. Specify 3 or 4 speed, make, model and year of car and emblem desired... \$3.75. Also available in plain walnut without emblem... \$3.75.



Walnut T-Bar

This innovation in interior ornamentation was designed exclusively for the 1968 Shelby Cobra K.R. Center section is a one piece die casting with triple chrome plate. Comes complete with a special lock-out button. Installs in minutes on all Ford or Ford Division produced cars with floor mounted automatic shift. You have a choice of inlaid Cobra, Mustang or Cougar emblem. Specify make, model and year of car and emblem desired ... \$5.95. Also available in plain walnut without emblem ... \$4.95.



Wood Rimmed Steering Wheel

Italian made wood rimmed steering wheel improves the appearance of any automobile. Kit includes steering wheel with complete horn mechanism. Real wood is permanently attached to welded stainless steel hub and spokes. Horn mechanism is complete and operates from center button. Installs in minutes with removal of one nut; no alterations or other changes necessary. Fits all Mustangs 1965-68 except those with tilt-away steering columns. Must specify year. Will not fit early 1965 Mustangs with generator... \$49.95.

Leather Wheel Glove

Made of the finest quality English glove leather. Foam backed for added positive traction. You'll enjoy the added pleasure this leather wheel glove will give to your driving whether in Sunday traffic or on the raceway. Available in black or tan in two sizes; "A" fits 15" to 16" O.D. wheels (most American made cars). Size "B" fits 16½" to 18" O.D. wheels. Specify color and O.D. of wheel...\$6.95.





Face Shields

Snap-on bubble face shield mounts on Shelby-Cobra Helmet in seconds. Comes in clear or smoke green for sunnier days. Clear... \$4.95. Smoke green... \$5.50.

Shorty Visor and Half Shade Shield. Shorty Visor... \$1.50. Smoke green Half Shade Shield... \$.75.

Italian Racing Goggles

For the professional driver who demands the best in protective equipment. Shatter-proof lenses in four panels allows for greater wide angle vision. Lenses may be of clear or smoke gray glass... \$10.95 includes carrying case. Replaceable lenses in a set of four pieces... \$7.95. Additional strap... \$1.95.

Racing Goggles. Supplied with clear or smoke green plastic lens... \$2.95. Replaceable lenses... \$.65 ea.





Shelby-Cobra Helmet

Shelby-Cobra Helmet meets the highest standards of materials, craftsmanship and safety. It is Snell Foundation approved and meets the requirements of USA Standard Z90.1. The Shelby-Cobra Helmet is available in Red, Blue, White and Silver Gray. Available in sizes from 6¾ to 7½. Specify color and size when ordering. \$29.95, includes visor.

This cross-section graphically illustrates why the Shelby Cobra Helmet passed the highest safety standards set forth by the Snell Foundation.



Fobs & Nobs

matching gift sets



T-Bar and Key Chain

The T-Bar is of the finest quality hand rubbed walnut with your choice of inlaid silver-plated Cobra, Mustang or gold-plated Cougar die cast emblem. Installs in minutes on all Ford or Ford Division produced cars with automatic floor shifting. T-Bar kit comes complete and includes lock-out button. Specify make, model and year of car. This ideal gift set features a key chain with matching Cobra, Mustang or Cougar emblem mounted on a florentined base. Set . . . \$6.95

Knob and Fob

Durable leathergrained vinyl stitched to walnut shiftknob and capped with your choice of Cobra, Mustang or Cougar cloisonne emblem. Matching cloisonne emblem is featured on English made key fob to round out this handsome gift package. Shift knob fits all Ford or Ford Division produced cars with three or four speed "stick shift" transmissions. Specify make, model and year of car. Set \$5.95



Walnut Knob and Key Chain (not illustrated)

The very finest shift knob on the market today. Hand rubbed walnut capped with your choice of Cobra, Mustang or Cougar cloisonne emblem and matching top quality key chain. Shift knob fits all Ford or Ford Division produced cars with three or four speed "stick shift" transmissions. Specify make, model and year of car. Set \$4.95



A



10

B

C

D

E

F

G

cobra jewelry

Since Carroll Shelby first combined the AC-Bristol body to the small Ford V8 engines, racing history was turned upside down and a dream became a legend. The following accessories were designed for the person that understands and appreciates that legend and what the name Cobra stands for.

- A Cobra Medallion and Chain. This is the Groovey Look! Goes great with the Cobra driving jacket and mock turtleneck. Gold or silver plated. \$4.95
- B Cobra Earrings. Wonderful gift item. Gold or silver plated. Clasp earring. . . \$4.50. Pierced earring. \$4.95
- C Necklace. Sculptured Cobra mounted on florentined base. Gold or silver plated. \$3.95
- D Oval Key Chain. Sculptured Cobra mounted on oval florentined base. Braided mesh chain. Gold plated only. \$1.95
- E Round Key Chain. Sculptured Cobra mounted on round florentined base. Braided mesh chain. Silver plated only. \$1.95
- F Cigarette Lighter. Weatherproof fluid type lighter. Features raised Cobra emblem on side. \$2.95
- G Butane Lighter. Lightweight, easy lighting, finely detailed. A real quality gift. Gold plated. \$5.95
- H Lapel Pin. Three dimensional Cobra is crafted in fine jewelers detail. Gold or silver plated. \$1.95
- I Tie Tack. Sculptured Cobra with attaching chain and bar. Gold or silver plated. \$1.95
- J Carroll Shelby (CS) Tie Tack or Lapel Pin. Finely detailed. Silver plated. \$1.95
- K Cobra Cuff Links. Dimensional Cobra mounted on hinged base for easy insertion. Gold or silver plated. \$2.95
- L Tie Bar. Dimensional Cobra mounted on spring activated tie bar. Gold or silver plated. \$1.95
- M Money Clip. Spring activated to tightly secure your paper currency. Silver plated. \$2.95
- N Cobra Key Fob. Made of finest English grained leather and features colorful fired enamel cloisonne emblem. \$1.95



ford jewelry

The familiar blue Ford "Oval" has been the symbol of superior automotive products to Americans for many years.

A Cuff Links—ideal for matching tie tack or tie bar. Mounted on hinged base for easy insertion. \$2.95

B Cigarette Lighter—wind-proof, sturdily constructed to last. Ford emblem mounted to face. \$2.95

C Key Chain—Ford emblem mounted to silver florentined base. Features quality flexible metallic braid. \$1.95

D Tie Tack—blue fired enamel with raised chrome detail; \$1.95

E Tie Bar—blue fired enamel with raised chrome detailing mounted on spring activated clip. \$1.95

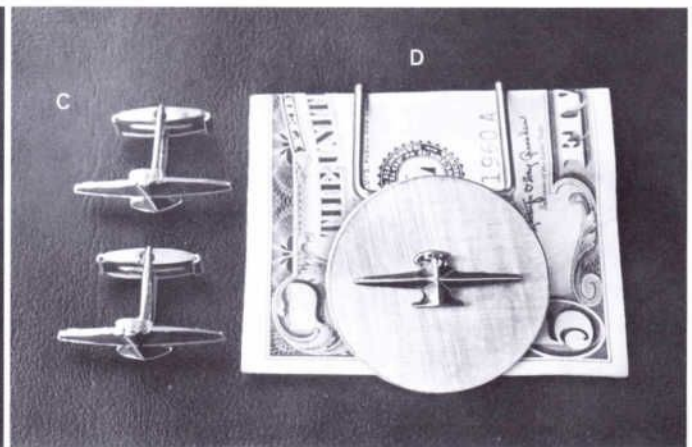
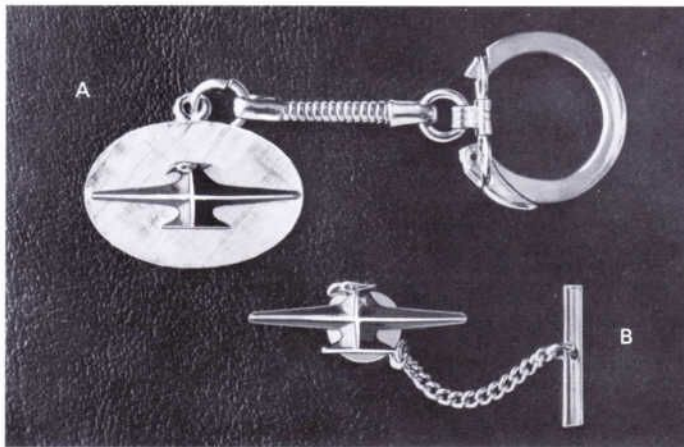
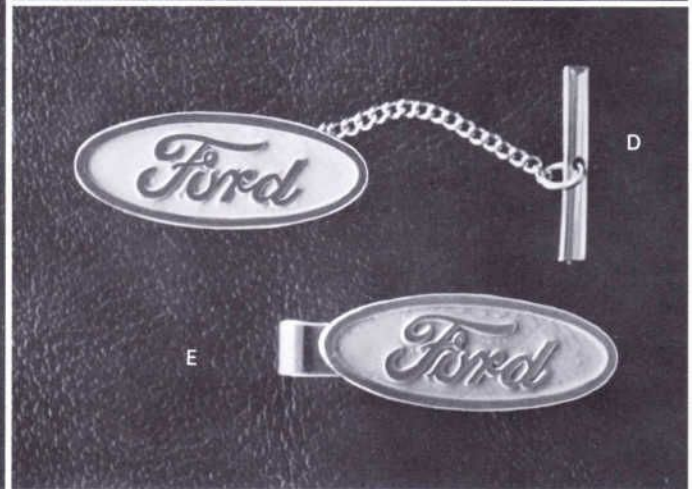
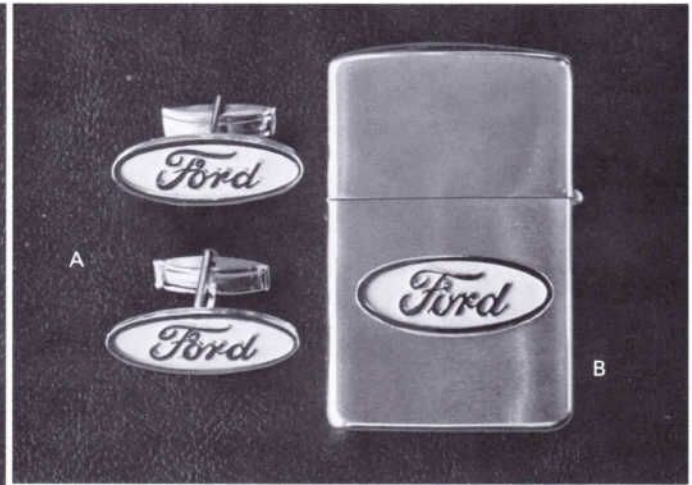

thunderbird jewelry

Since the introduction of this car in 1955, the Thunderbird has captured the admiration of the American public and started a major revolution in the automotive industry. Shelby Accessories offers this collection of jewelry items featuring the Thunderbird emblem to those privileged owners of this fine automobile.

- A Key Chain**—Thunderbird emblem mounted on oval florentined base. Features top quality flexible metallic braid, gold plated. \$1.95
- B Tie Tack**—three dimensional Thunderbird emblem crafted in exacting detail, gold plated. \$1.95
- C Cuff Links**—outlined three dimensional Thunderbird emblem on hinged base for easy insertion, gold plated. \$2.95
- D Money Clip**—Thunderbird emblem mounted on florentined oval. Finely detailed and finished, gold plated. \$2.95

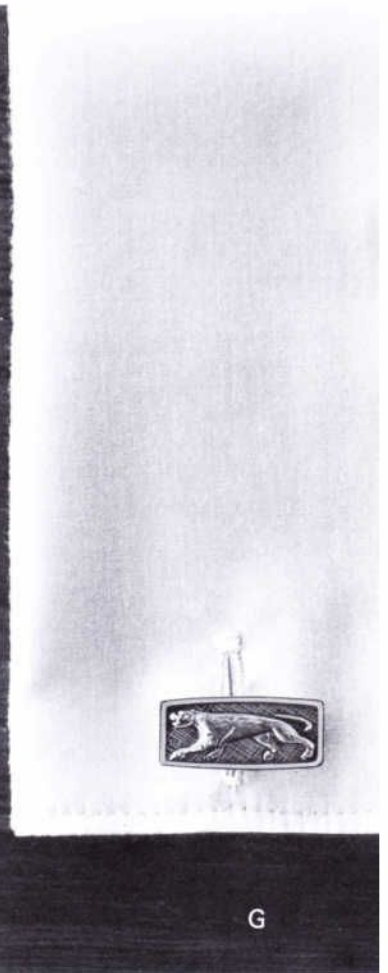
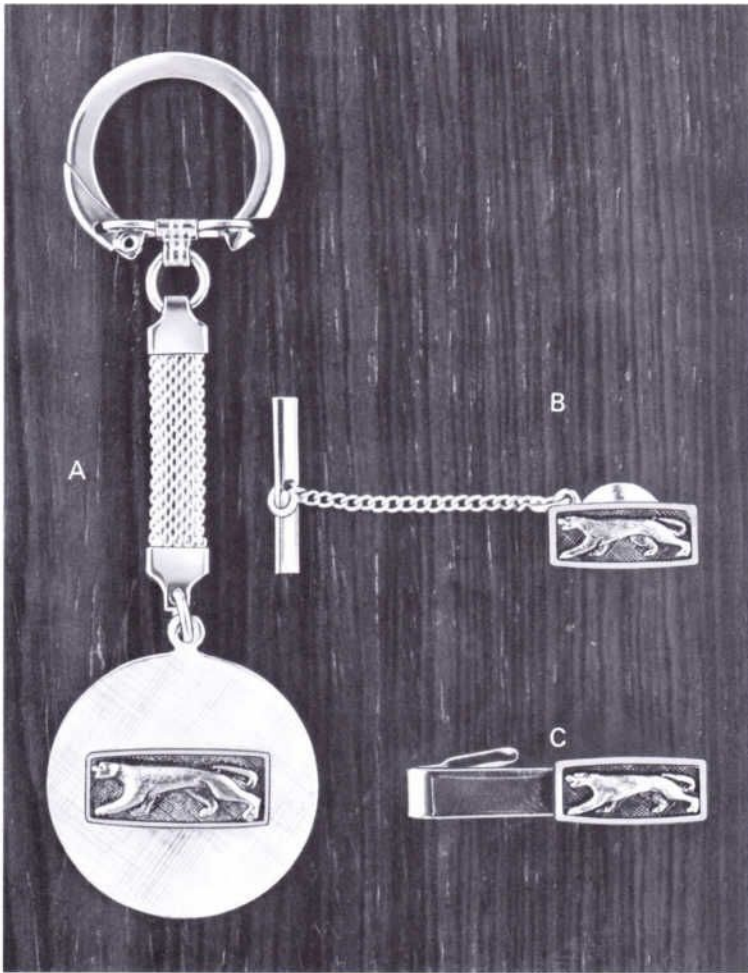

cougar jewelry

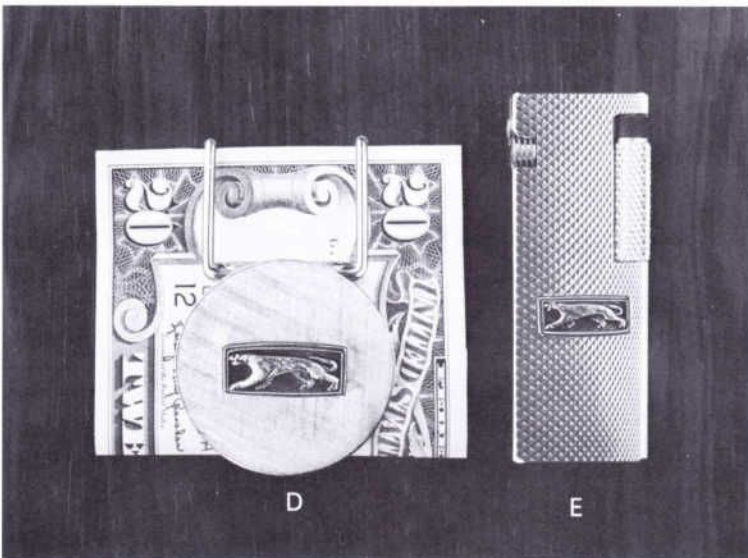

The Lincoln-Mercury Division of the Ford Motor Company is justly proud of the introduction of this relatively new car to the American automotive scene. The luxury of this fine automobile is reflected in quality of Cougar accessories offered on this page.

- A Key Chain; Cougar emblem mounted on oval florentined base. Features top quality metallic braid, gold plated \$1.95
- B Tie Tack; dimensional Cougar emblem with attaching chain, gold plated \$1.95
- C Tie Bar; dimensional Cougar emblem mounted on spring activated clip, gold plated \$1.95
- D Money Clip; Cougar emblem mounted on florentined oval. Spring activated to tightly secure money, gold plated \$2.95
- E Butane Cigarette Lighter; finely crafted and lightweight, a true quality gift, gold plated \$5.95
- F Leather Key Fob; made of finest imported leather and features colorful Cougar cloisonne emblem. \$1.95
- G Cuff Links; ideal for matching tie tack and tie bar, hinged base for ease of insertion, gold plated \$2.95

mustang

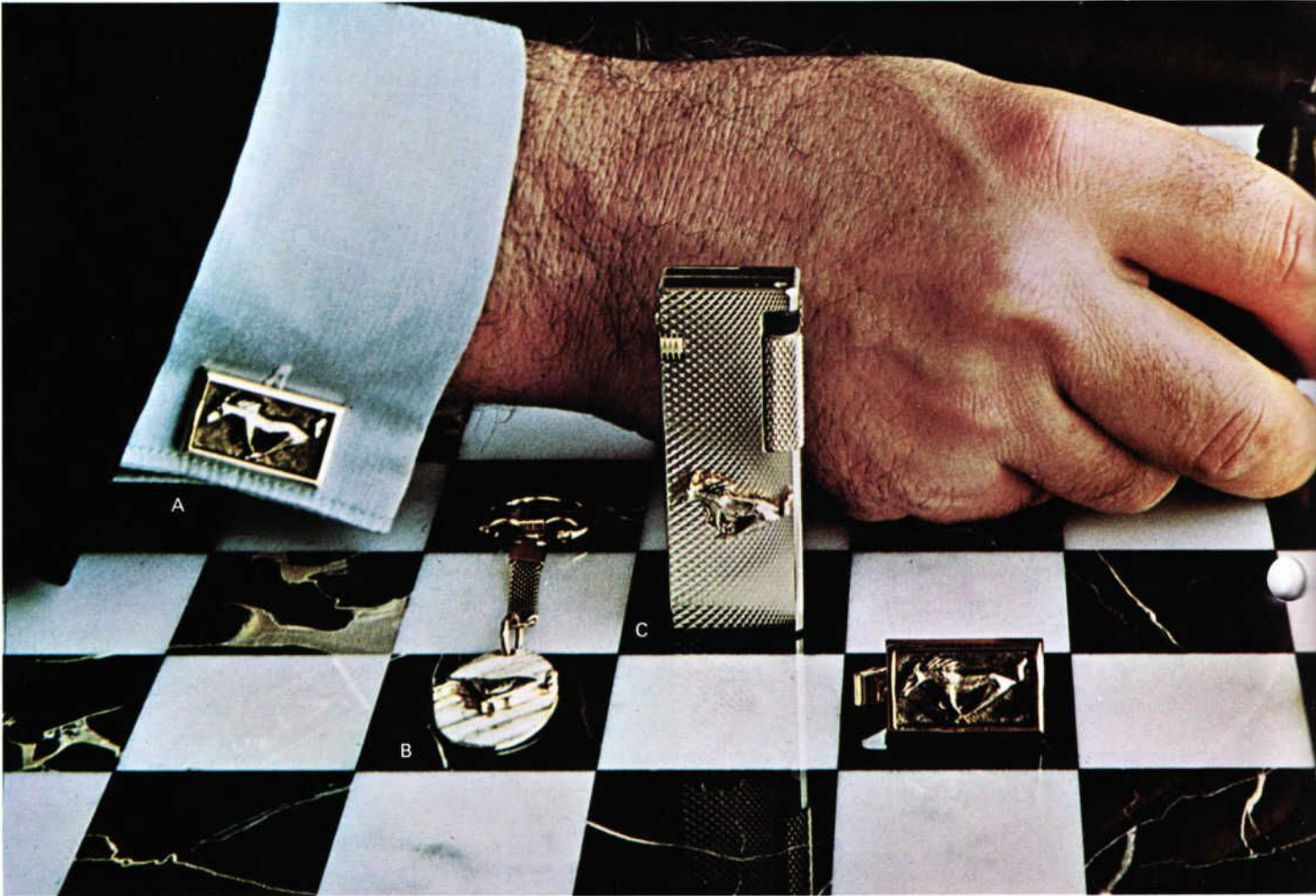

Money Clip—spring activated to secure your paper currency tightly; silver plated . . . \$2.95

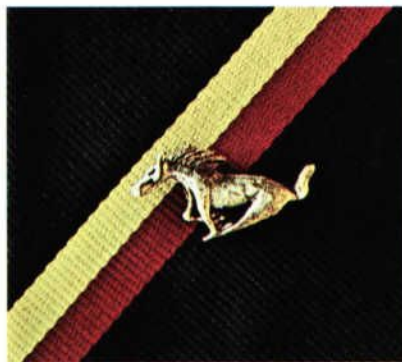

Tie Tack—three dimensional Mustang crafted in fine jewelers detail; gold or silver plated \$1.95



Tie Bar—dimensional Mustang mounted on top quality tie bar clip; gold or silver plated \$1.95

jewelry

Since its introduction in 1965, the Ford Mustang has captured the fancy of the public both in sales and admiration. The Mustang has particular meaning to those who take a special pride in owning one of these fine automobiles. For this reason, Shelby Accessories has assembled the finest crafted jewelry available featuring the well known Mustang.

- A Cuff Links—sculptured Mustang mounted to florentined base. Handsomely styled for special occasions, gold or silver plated... \$2.95
- B Oval Key Chain—sculptured Mustang mounted on florentined base. Braided mesh chain. Gold plated only... \$1.95
- C Butane Lighter—adjustable flame, finely detailed—makes this lighter the ideal gift. Gold plated... \$5.95
- D Mustang Necklace—Ideal gift for the woman who shares your enthusiasm for the Mustang car. Sculptured Mustang mounted on florentined field, gold or silver plated... \$3.95

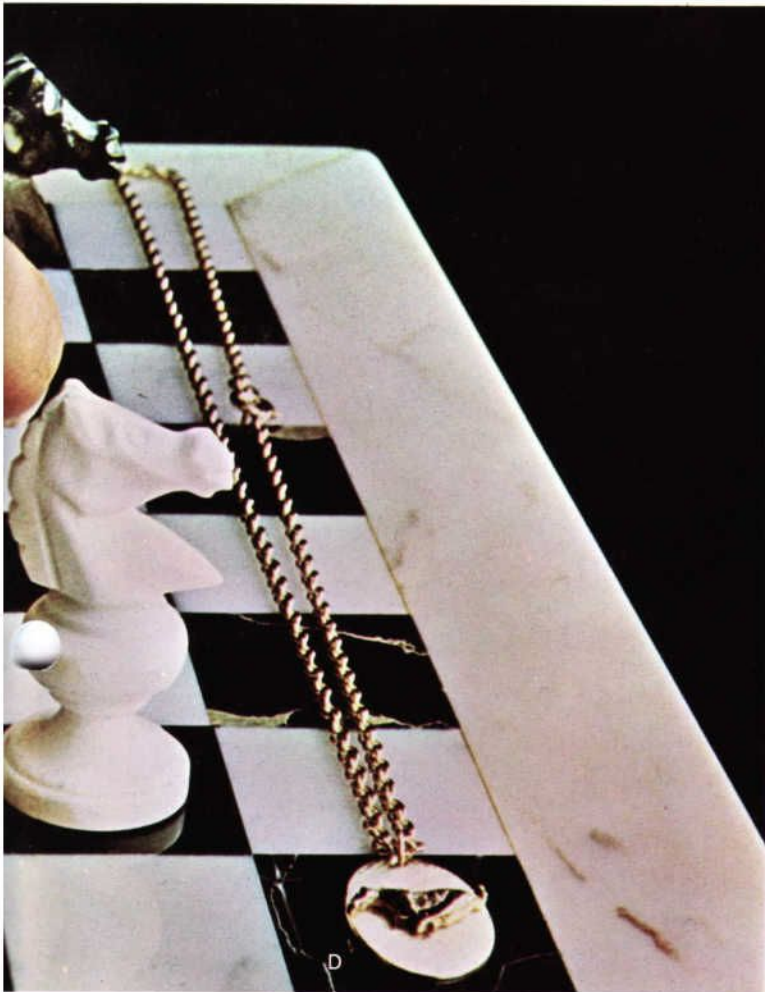

E Pin—finely detailed Mustang fits handily in lapel of your suit; silver plated; \$1.95

Mustang Key Fob—made of finest English grained leather and features cloisonne emblem... \$1.95

Cigarette Lighter—fluid-type lighter is virtually weatherproof. Designed to light and last longer. Silver plated... \$2.95

Round Key Chain—attractively designed and manufactured to last. Braided mesh chain. Silver plated only... \$1.95

Shelby Racing Mirror

Self-tapping screws make mounting universal. Mirror features heavy chrome finish and fully adjustable face. Gives your street or race car the look it deserves... \$5.95

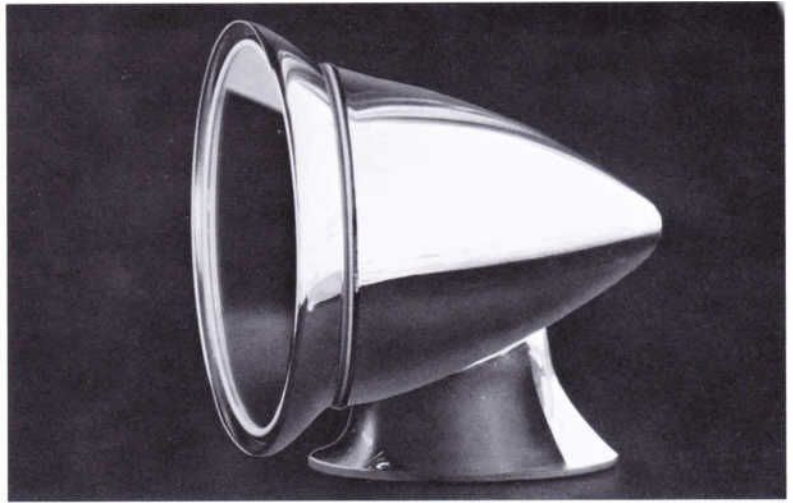

Hood Pin Kit

Positive lock on all hoods by firmly attaching the front end; hood cannot loosen at high speeds.

Gives your car the Mach 1 look that is so popular this year.

Whether for race or street, this is the kit to buy. Easily installed on all cars with slight do-it-yourself modifications.

Make your car look its best.

Each kit includes two stainless steel washers with a special 3M self-adhesive backing which eliminates awkward sheet metal screws and rivets. Kit also includes

2 stud pins, 2 klik pins,

4 nuts and complete installation instructions.

A Hood Pin set with attaching vinyl coated stainless steel cables... \$6.95.

B Hood Pin set without cables... \$4.95.

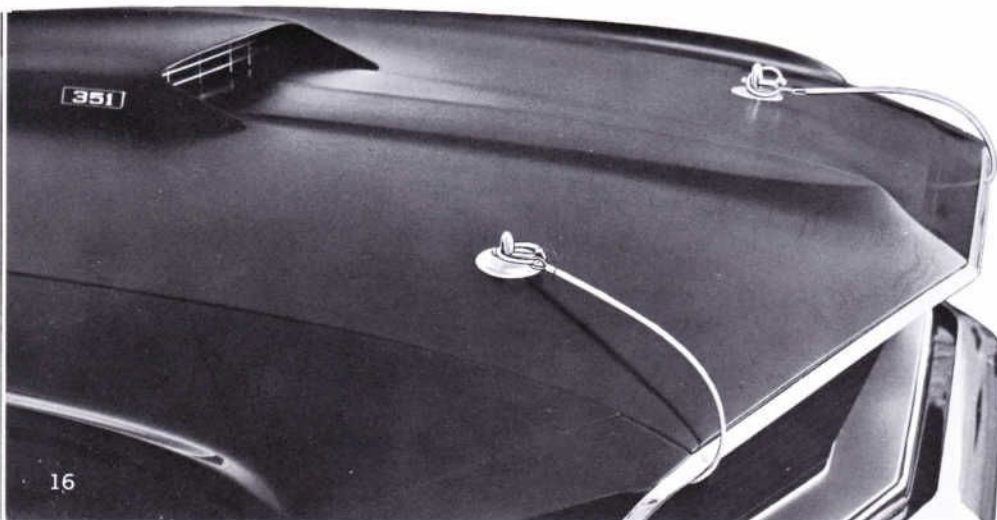
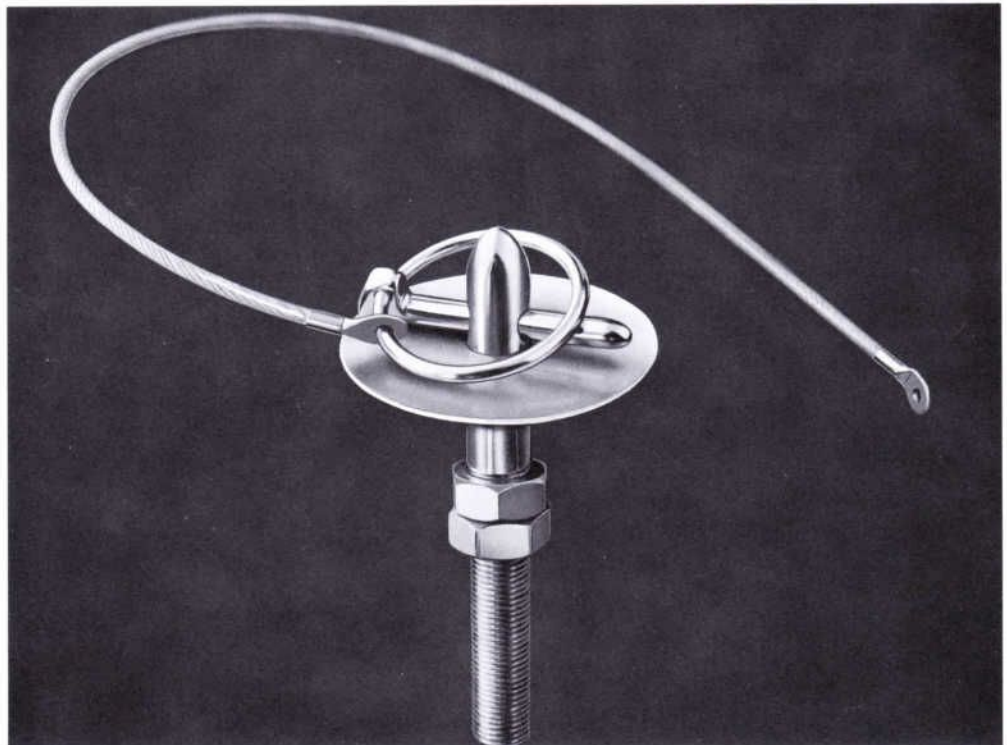

All emblem plaques on this page A through D are backed with a special 3M self-adhesive eliminating any drilling into the body or dash of your car. This special 3M material is the same self-adhesive used in mounting emblems on all the new Shelby cars. Emblems E through H can be applied to any flat surface with an epoxy or solder.

A Cobra 428 Jet	\$3.95
B Cobra Jet	\$3.95
C Cobra, gold or silver plated	\$3.95
D Shelby-Cobra, silver plated only	\$2.95
E Small Cobra, gold or silver plated	\$1.50
F Small Cobra with lettering, silver plated only	\$1.95
G Small Mustang, silver plated only	\$1.50
H Small Cougar, gold plated only	\$1.50



A



B



C



C



D

Car Plaques

The following car plaques can be mounted to the dash, hood, deck lid, fenders or almost any place that your creative spirit directs. They are made of non-corrosive diecast metal, and built to last.



F



E



G



H



new cobra driving jacket

Rugged good looks combined with Continental styling make this the greatest casual jacket going. Made of finest quality double gauge 100% Oxford nylon. Features ringed zippers on cuffs and jacket front. Includes Swiss embroidered Cobra patch. May be ordered without patch on special order. Jacket in blue only... \$19.95.

Also available: with red quilted zip-in liner (shown at right) this jacket converts into the first All Year Driving Jacket. Liner... \$5.00. Specify jacket size, S, M, L, Ex L.





A



B



C



D



E

Embroidered Jacket Emblems

Many of these newly designed patches are being offered for the first time exclusively by Shelby Accessories. They are Swiss embroidered in full color. Emblems maintain their vivid colors when washed. See full listing of patches on page 2.

A Cougar	\$1.00
B Cobra on Wheels	\$1.50
C Square Cobra Patch	\$1.50
D Mach I	\$1.50
E Square Mustang Patch	\$1.00

Mock Turtleneck

Mach I—Mock Turtleneck
 This mock turtleneck is as "In" in styling as the Mach I. It's warm, comfortable, good looking and made of finest quality 100% Orlon knit—machine washable, of course. Short sleeves only. Comes in sizes S, M, L, Ex L... \$9.95.



Shelby-Cobra Sweatshirt

Made of finest quality American made cotton. Features Cobra emblem on front and the word "Cobra" on the back. Sizes S, M, L, Ex L... \$3.95.

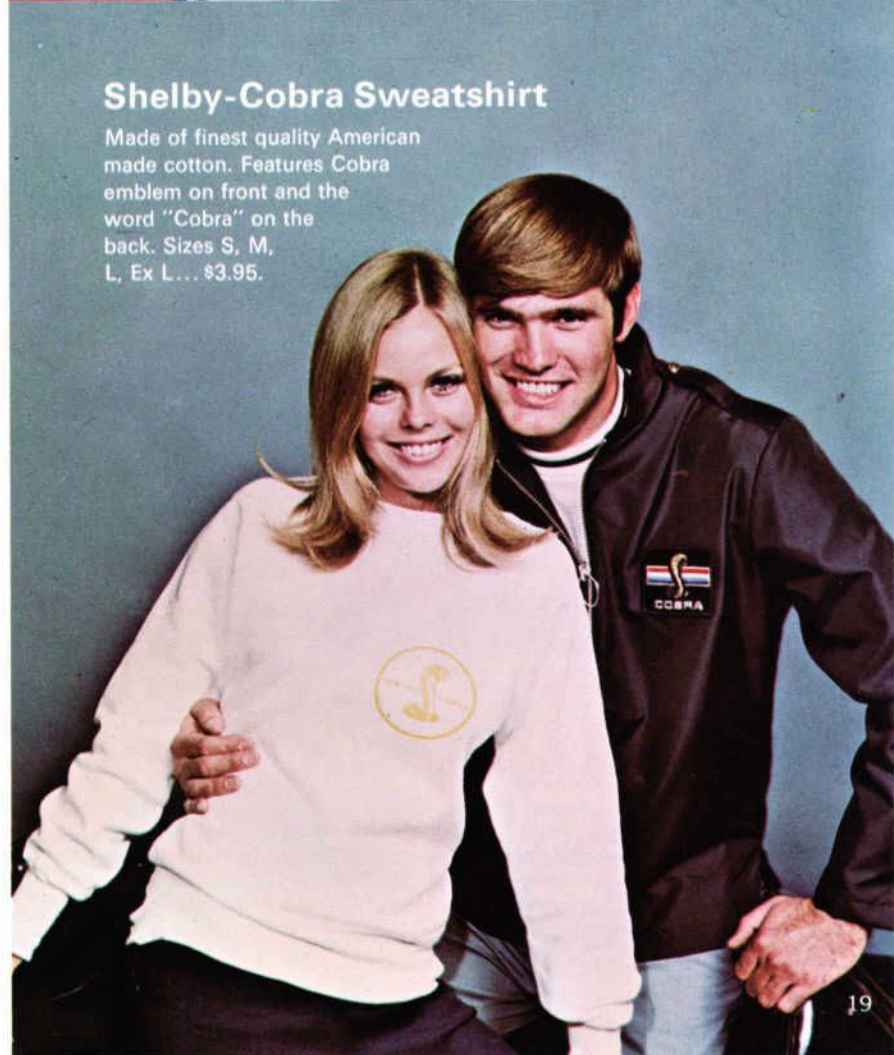

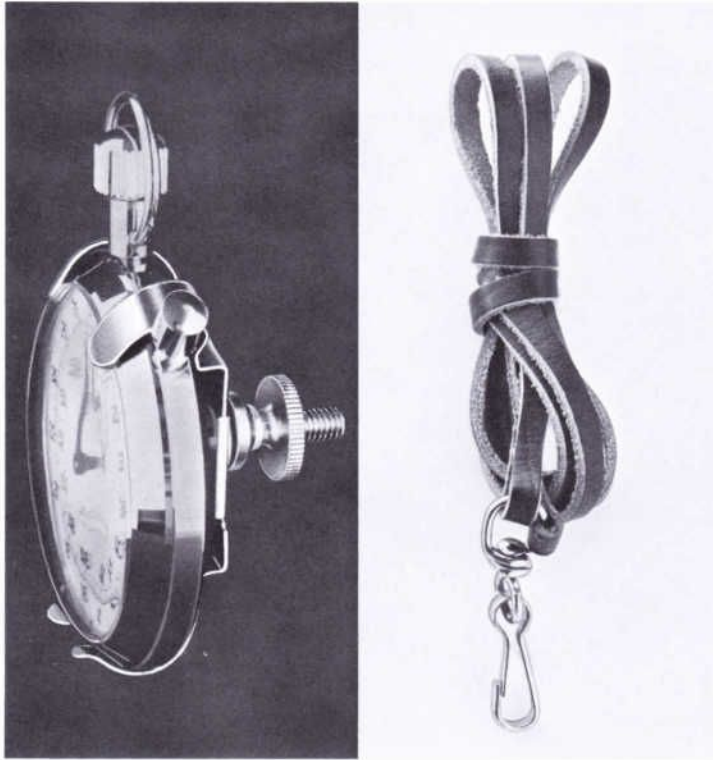

Chrome Switch Panels

Installs under dash. Single panel with one on/off switch, \$2.50. Two hole panel with two on/off switches, \$3.50.

Stop Watch Holder

Adjustable watch clip takes all normal size pocket and stop watches. Screws into dash or rally clip board, \$2.00.

Leather Stop Watch Strap

Worn around neck or attaches to belt strap. Made of top quality rugged leather, \$1.50.



Maserati Triple Air Horns

This famous Italian air horn features three trumpets of durable corrosion resistant red plastic and gives great penetration and carrying power. A fingertip switch gives choice of either three alternating tones or one tone in unison. Complete with compressor, switch, relay, tubing, mounting brackets and installation instructions. Available in 12 volt. Kit complete, \$29.95. Kit with H/D compressor, \$39.95. Add \$5.00 for chrome trumpets.

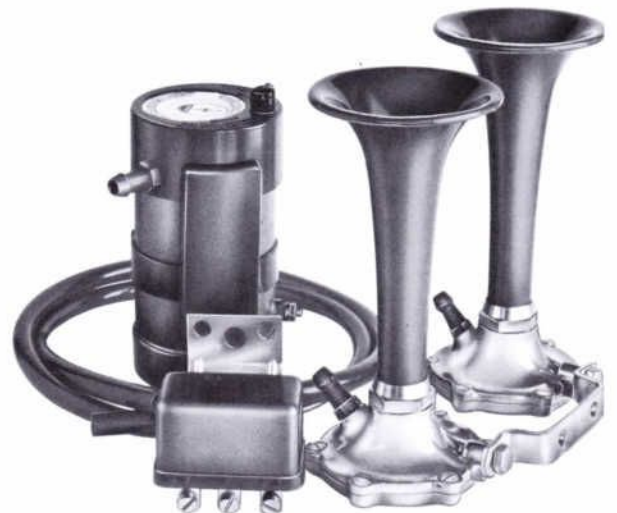

Maserati Dual Air Horns

Compact and lightweight. Kit includes compressor, relay, tubing, mounting brackets and installation instructions. Made of corrosion resistant red plastic. 12 volt. Complete kit, \$19.95, add \$4.00 for chrome trumpets.



Shelby Jump Suit

Lightweight Shelby blue poplin makes this attractive jumpsuit ideal for wear to sports car events, rallies, drag races or wherever automobile enthusiasts get together. Comes with your choice of emblem (not attached). See selection on pages 2 and 19. Available in blue only. Sizes, Small 36, Medium 38, Large 40, Extra Large 42-44 . . . \$18.95



Shelby High Performance Parts Catalogue

Carroll Shelby has a long history for getting the best possible performance from Ford produced cars. In his high performance parts catalogue he offers some of the equipment that makes this outstanding performance possible. Catalogue and decal . . . \$1.00



Cobra Tachometer

Fully transistorized. No sending unit or additional equipment necessary. Track tested and approved for maximum accuracy and reliability. Three inches in diameter, dial has 250° sweep, 0-9000 action, and is fully illuminated. Easy to install on all Ford cars with 12 volt systems; fits other makes with minor rewiring . . . \$29.95

A Fleece Lined Racing Jacket

If you are looking for a jacket with comfort, warmth and style—this is it! Top quality Oxford nylon. Features a concealed hood, elasticised wrist and drawstring bottom. Available in blue only. Price includes Cobra emblem. Sizes S, M, L, Ex L. . . . \$18.95

B Cobra Windbreaker

This jacket is a real standout at any event. Quality 100% Oxford nylon by Monsanto. Ideal as a club jacket. Price includes seven color Swiss embroidered Cobra patch and racing stripes. May be ordered without patch. Available in white or blue nylon. Specify size; Children's S, M, L; Women's S, M, L; Men's S, M, L, Ex L. Price. . . . \$10.95



Cobra T Shirts

- A Cobra Champ. Backside commemorates the great wins that this car made to put America back on the international racing scene. Sizes Ex S, S, M, L, Ex L... \$2.00
- B GT 350. Proud addition to any racer's wardrobe. Blue racing stripes front and back. Sizes Ex S, S, M, L, Ex L... \$2.00
- C Cobra Champ Giant T Shirt. Made in comfortable "tent size". This T shirt is ideal for races, beach wear or whatever. Some people think this was the original Cobra nightgown, but don't you believe it! Sizes, Extra Big only... \$2.00
- D Don Prudhomme "Supersnake" T Shirt. Don Prudhomme driving the Shelby Supersnake is well known throughout the country. This year he was chosen by the Sports Writers of America as Drag Racing's Driver of the Year. Sizes Ex S, S, M, L, Ex L... \$2.00



A

B



C



D

Cobra Glasses Mugs & Ashtray



The Shelby-Cobra mugs, glasses and ashtray are designed and produced for those individuals who share an enthusiasm for the legend of the Cobra cars that Carroll Shelby designed, built and raced to two world championships.

A Shelby-Cobra Ashtray. Ideal for the enthusiast. A man's ashtray 7" in diameter. White ceramic, fired in 23 karat gold \$2.95

B Shelby-Cobra Beer or Coffee Tapered Mugs. White ceramic, fired in 23 karat gold.
9 oz.... \$2.95 14 oz.... \$3.50

C Shelby-Cobra Coffee or Beer Square Tankards. White ceramic fired in 23 karat gold.
14 oz.... \$3.50 28 oz.... \$3.95

D Shelby-Cobra Tumbler. Fired in black enamel.
Set of four \$2.95

E Shelby-Cobra Cocktail Glass. Fired in 23 karat gold, set of four \$3.95

F Pilsner Glasses. Fired in 23 karat gold, set of four . . \$3.95



A

B

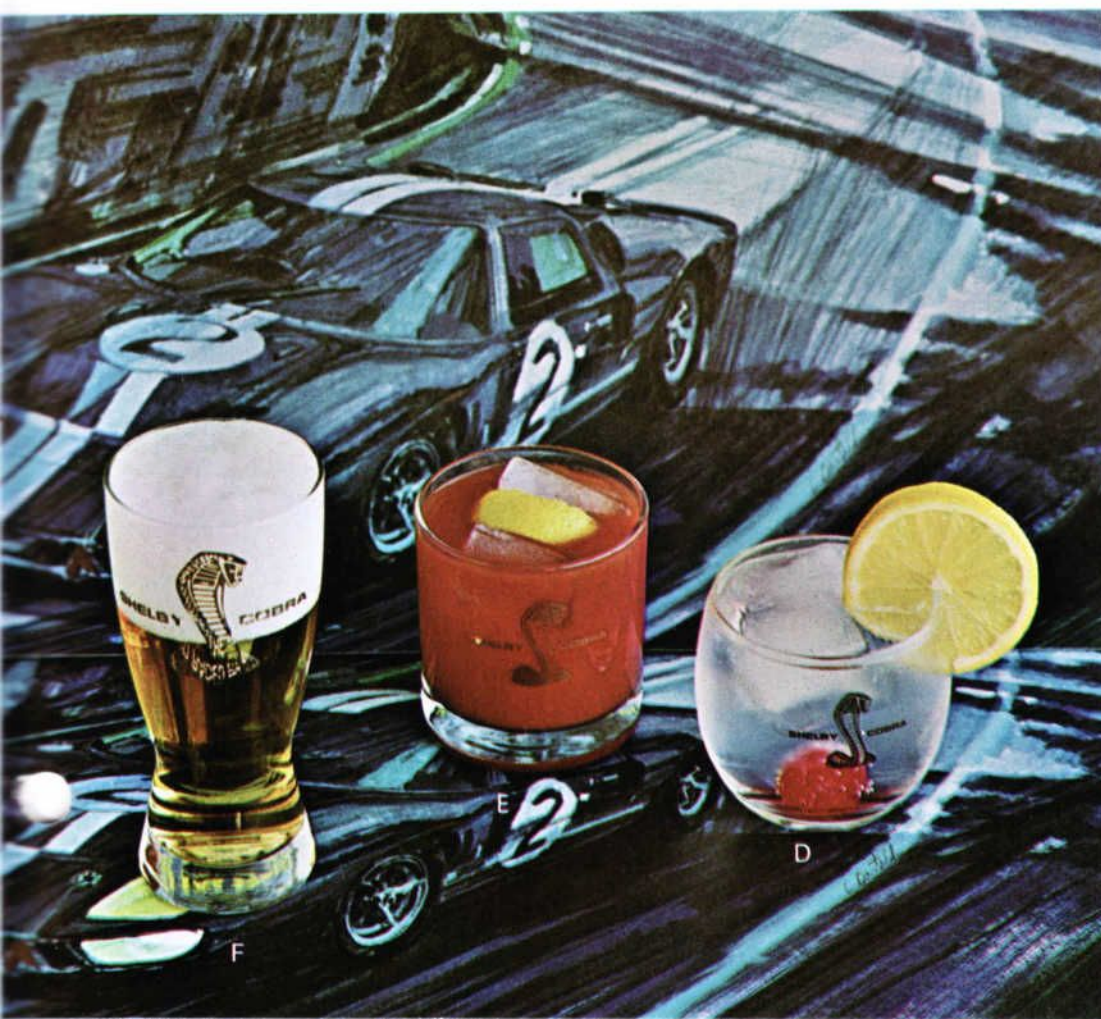

F

E

D





A



B

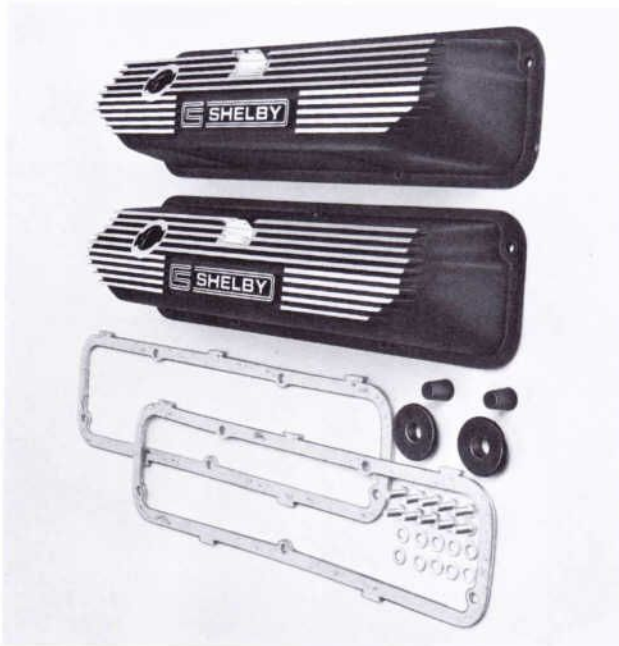

C



D

Engine Dress-Up Kits

A Shelby Super-Flow Single—Die cast finned aluminum top is designed to match the pattern and finish of our valve covers. This is the same air cleaner as used on the 1968 Shelby GT 350's and GT 500's. This single 4V air cleaner is designed to fit all Ford and Holley carburetors. Please specify make, model and year of car... \$28.00

B 0-9000 RPM Tachometer—Kit includes fully transistorized tachometer and mounting screws. No sending unit or additional equipment necessary. Dial has 250° sweep, 0-9000 action, and is fully illuminated. Used on all V8 Ford cars with 12 volt systems; fits other makes with minor rewiring... \$29.95.

C Valve Covers—Make your engine look like the hot performer it really is. Shelby Valve Covers with their finned, die-cast aluminum construction and zinc-coated steel internal baffling not only enhances the appearance of your engine, but also helps dissipate heat and muffle tappet noise. Finished in black crackle to contrast with the satin-ground fins. Shelby Valve Cover Kits come complete with gaskets, special grommets for PV vents, plated bolts and washers.

221-302 CID Valve Cover Kit... \$29.95

352-428 CID Valve Cover Kit... \$37.95

D Full-Flow Air Cleaner—This air cleaner was developed specifically for the high volume requirements of the Holley 3-Barrel Carburetor and is ideal for any 4-Barrel installation. Allows the carburetor to breathe and flow at its best... \$19.50.

Lucas Square 8

Quartz-Halogen Fog and Long Range Driving Lamps

If these beautifully designed matched pair of Lucas Accessory lamps don't add "Sex Appeal" to your car, nothing will! Powerful quartz-halogen bulbs (200,000 candlepower) are combined with Lucas beam-controlled lenses to provide the ultimate in accessory lamp performance.

Lamp housings are beautifully chromed brass. Both the Lucas Square 8 Fog and Long Range Lamps can be mounted in either upright or pendant hanging position and are adjustable for beam direction. 12 volt only.

A Lucas Square 8 Long Range Driving Lamp

\$25.95 ea. includes black vinyl lens cover with neoprene strap.

Fantastic Savings: Set of Two \$39.95

Includes Lens covers and single pull switch and dash panel.

B Lucas Square 8 Fog Lamp

\$18.95 ea. (does not include lamp cover)

Special Offer: Set of Two \$34.95

Includes lens covers and single pull switch and dash panel.

Check for state approval.



A



B

Switches and Panels

Single pull switch and dash panel...
\$2.50
Not Shown

Double pull switch and dash panel...
\$3.50



Square 8 Lens Covers

Snug fitting, heavy duty protective lens cover is made of black vinyl with neoprene strap. \$1.95 ea.



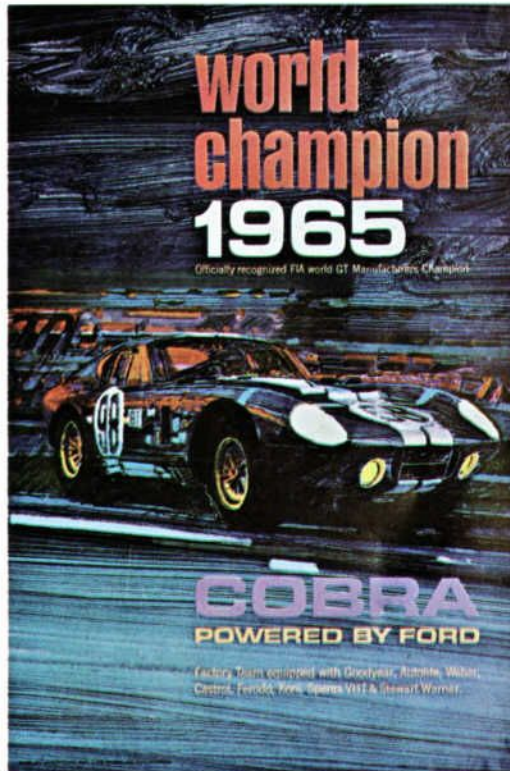

A

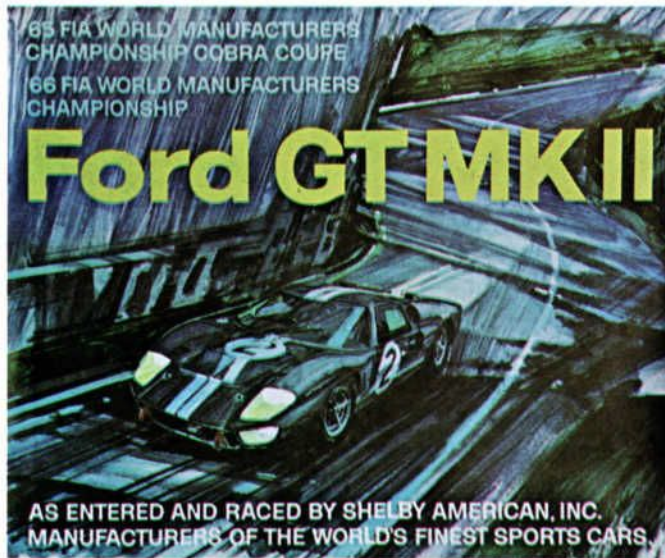

B

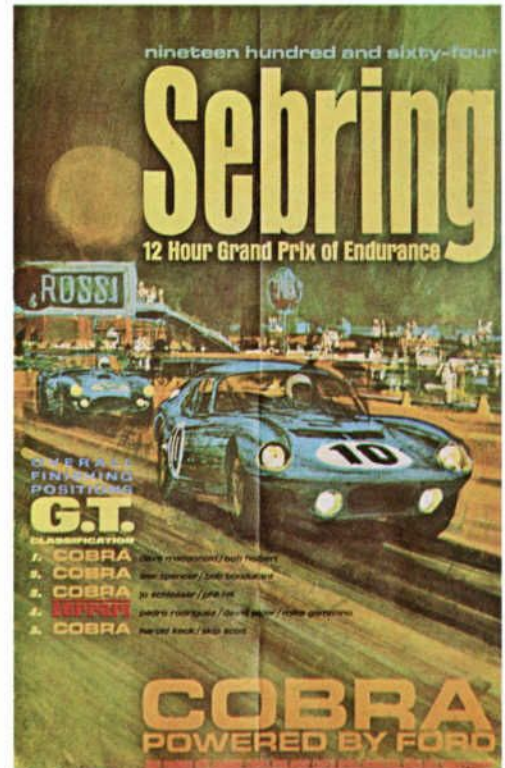

C



D

George Bartell Posters

illustrating great moments in the history of the Cobra cars. Set of all four... \$2.95.

- A. 1965 Cobra World Champion \$1.00 ea.
- B. Mark II Winning LeMans \$1.00.
- C. 1963 Sebring (folded) \$1.00 ea.
- D. GT 350 \$1.00 ea.

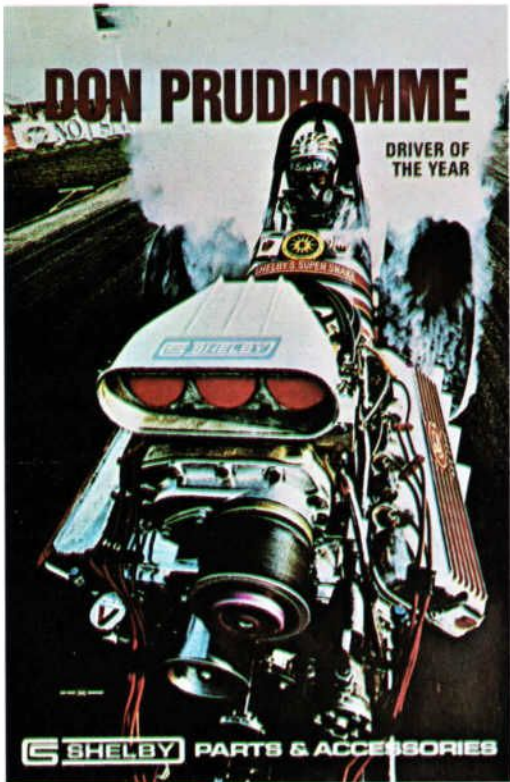

Racing Prints

Limited run racing prints reproduced on a soft finish paper stock; 12 x 18", ideal for framing. These prints are reproductions from Carroll Shelby's private collection of famous racing illustrations. \$1.50 ea., set of 4... \$5.00.

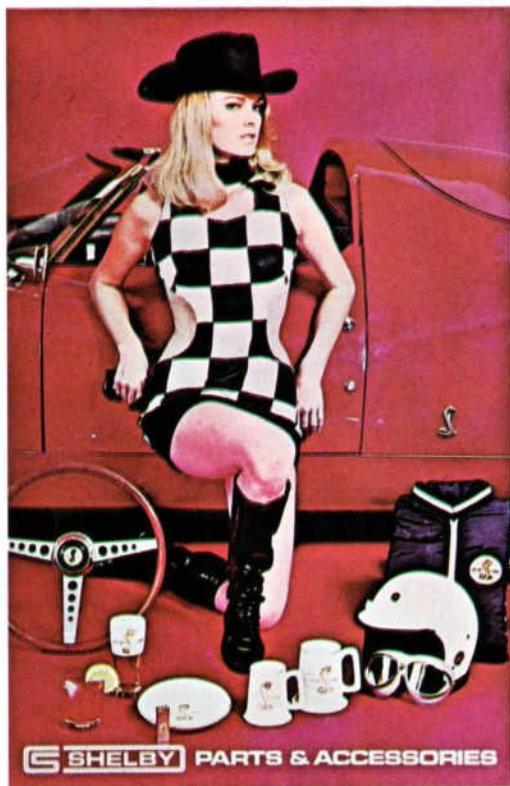

Shelby Posters

Shelby Parts and Accessories Giant Posters 28 x 34"
Don "The Snake" Prudhomme—Driver of the Year... \$1.50 ea.

Shelby Accessories Girl Poster... \$1.50 ea.

Both Giant Posters... \$1.95

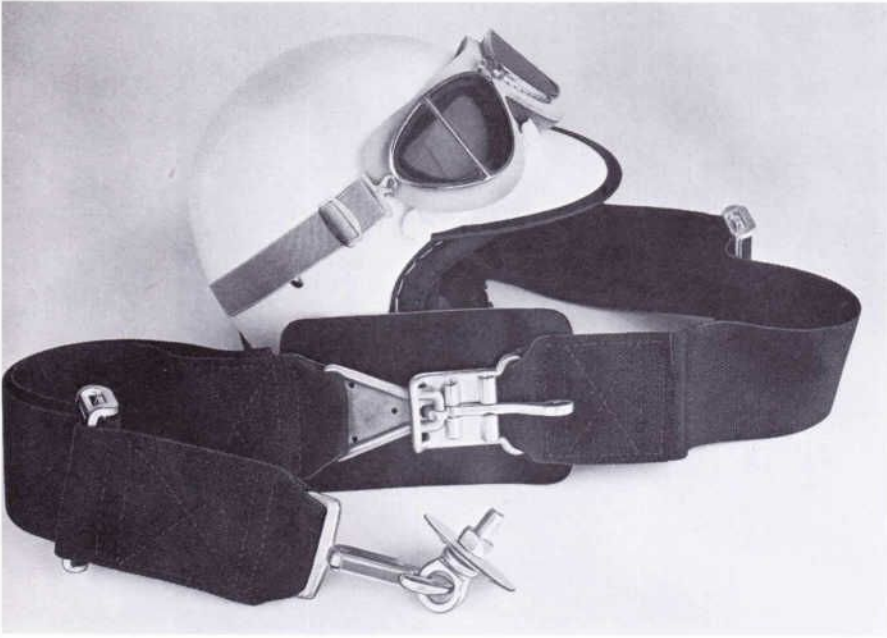

Competition Seat Belt and Shoulder Harness

Seat Belt is 3" wide, 9000 lbs. test nylon webbing, and features quick release latch with positive lock. Approved for competition by all racing associations ... \$23.00.

Shoulder Harness. Designed for use with 3" seat belt and assures a positive seating position. Adjustable at shoulder straps and point of floor mounting ... \$15.00.



Nomex Gloves

Approved and acclaimed by all racing associations. Strictly professional driving gloves, not recommended for street use. Double layer Nomex backs; sewn throughout with Nomex thread, Velcro wrist closures. English flameproof leather palms are impervious to all fluids. Available in sizes 7 to 11 ... \$13.95 pair.

suspension / handling

Koni Shock Absorbers

Here's the answer for those who are tired of just average handling. Competition proven by the best, fully adjustable Koni Shocks can be set for any type of handling you want. Will last 60,000 to 80,000 miles under normal driving conditions. No special work required to fit any Mustang 1965-69. Specify front or rear, year and model. Front... \$25.00 ea. Rear... \$25.00 ea.

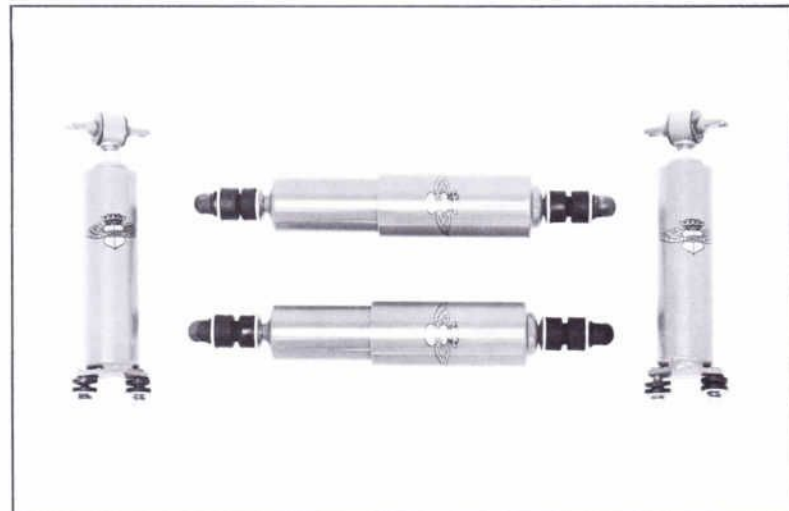

Front Stabilizer Bar

Kit includes 1" diameter steel bar, rubber grommet and mounting brackets. Heavy duty stabilizer bar improves handling, cornering and reduces sway. Used for both street and track. Fits all Mustangs 1965-69. Specify year.
65-66 Mustang... \$50.00
67-69 Mustang... \$50.00
Must specify year and model when ordering.



Bolt-On Traction Bars

These bars provide the same traction control as the weld-on type, but offer the advantage of Bolt-on installation. Can be installed in approximately one-half hour with simple hand tools. Fits all Mustangs 1965-68.
65-66 Mustang... \$39.45
67-68 Mustang... \$39.45
Must specify year and model when ordering.



Rear Stabilizer Bar Kit

Complete Kit as used on Mustang Race Cars. Kit includes all necessary components for installation. This kit gives real competition handling and positive rear body control. Exceptional results are achieved when used with our Front Stabilizer Bar and Koni Shock Kits. Fits 1965-66 Mustangs only... \$65.00.

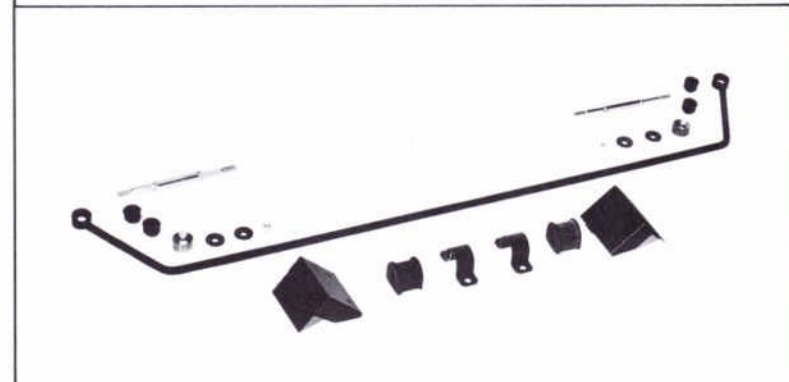

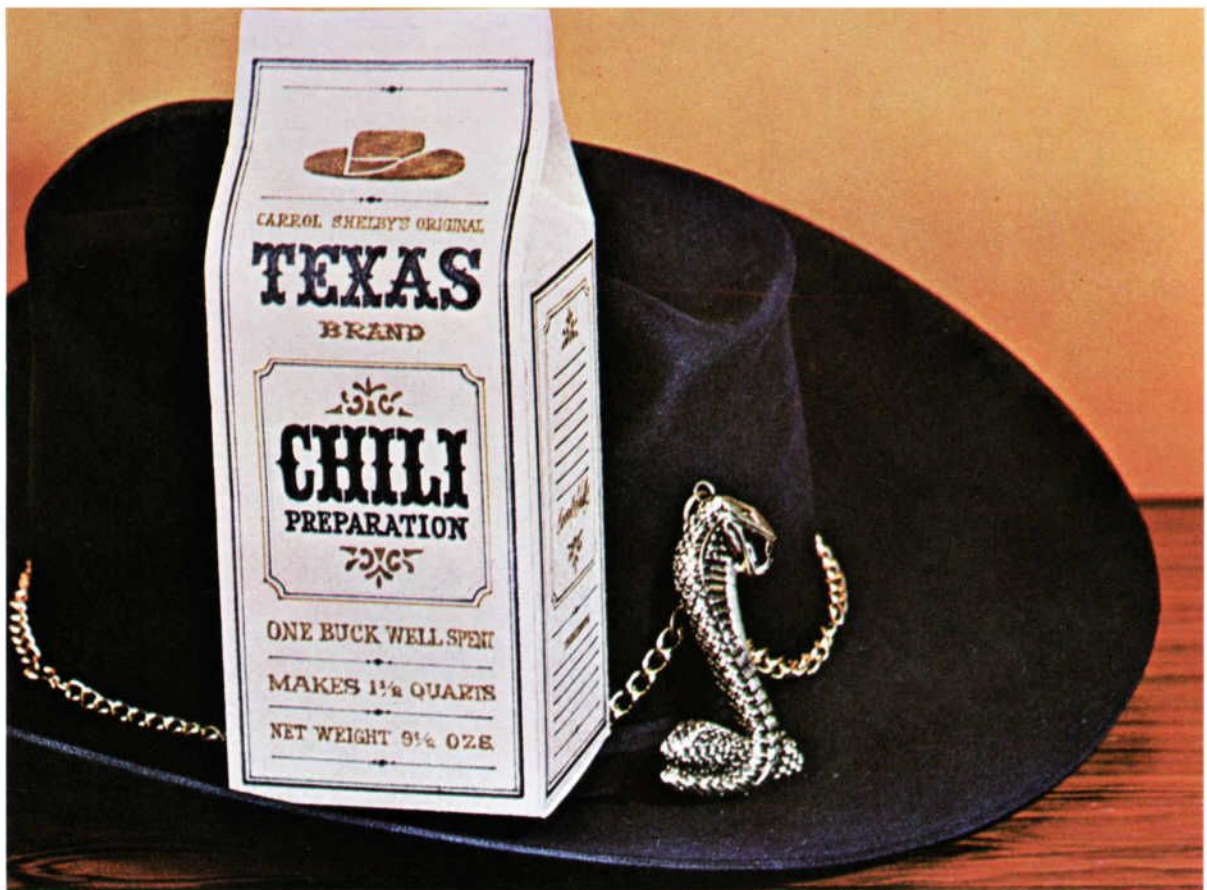

Texas Chili

In October, 1967 a contest was held at Terlingua, Texas to determine the world's champion chili cook. The opponents in this confrontation were Wickford P. Fowler, chief cook of the Chili Appreciation Society International, an organization formed in 1951 to spread the gospel of good chili around the world, and H. Allen Smith, the celebrated author of many humorous books, including "Life in a Putty Knife Factory."

Terlingua, known as "The Chili Capital of the World" (also home of the Terlingua Racing Team and site of the famous Chili Bean Grand Prix for unlimited hydroplanes), is a God forsaken dried up ghost town in the Big Bend country of Texas. The town was chosen to host the cook-off mainly because it sits on a 220,000 acre ranch owned by two prominent members of the Chili Appreciation Society, Carroll Shelby, well known sports car racer, retired, and David Witts, a Texas lawyer and Mayor of the town of Terlingua.

Over 1,000 spectators swarmed to Terlingua that fateful day to witness Smith and Fowler prepare their poison. The lines were drawn, judges were chosen, and the chili challenge was on. The dishes were served. The first judge ruled for Smith, but the second favored Fowler (a natural result in view of the bribes advanced by each contestant). Mayor Witts was to be the tie-breaker. He tasted one pot and paled. He sampled the other and spat it out. He had burned his taste buds and the contest was ruled a draw.

A rematch was held a year later, same time, same place. But the ill-fated festival again ended in frustration and fist fights when after the chili was cooked, the samples were tasted, and the votes were cast, a masked gunman appeared and absconded with the ballot box. The world was once again deprived of its champion.

Meanwhile, back at the ranch, Shelby decided to enter the foray. After all, real chili was conceived in Texas, and so was he. He came by his own original recipe honestly which no doubt was more than anyone else could say. Why deprive the world of it any longer?

Well, he won't. He has spared no effort to bring you one of the most unforgettable eating experiences you ever had. "Carroll Shelby's Original Texas Chili." This concoction hasn't won any prizes—yet; but it will turn out the tastiest, most eye watering bowl of red you ever ate. You can fix it tame or you can make it so the heat will jolt you; the roof of your mouth will corrode, and the tissues of your cheeks will contract like cellophane. However you prepare it, it's good for what ails you and it will shake the meanness out of the most ornery leathermouth chili head that was ever born. One package makes 1 1/2 quarts. Try it and you be the judge.



1 Package—\$1.00 plus 25c
postage and handling.
6 Pack—\$5.95 postpaid
Case of 24—\$19.95 postpaid

index

A	Air Cleaners	Page 26	M	Mirror—Racing	Page 16
	Air Horns	Page 20		Mock Turtleneck	Page 19
	Ashtray	Pages 24 & 25		Mugs	Pages 24 & 25
B	Bubble Shields	Page 7		Mustang Jewelry	Pages 14 & 15
C	Car Plaques	Page 17	N	Nomex Gloves	Page 30
	Cobra Jewelry	Pages 10 & 11	P	Posters	Page 28
	Cobra Story	Page 1		Prints	Page 29
	Cougar Jewelry	Page 13	S	Seat Belt Competition	Page 30
D	Decals	Page 2		Shelby High Performance Parts Catalog	Page 21
	Drinking Glasses	Pages 24 & 25		Shift Knobs	Pages 4 & 5
	Driving Gloves	Page 3		Shoulder Harness, Competition	Page 30
	Driving Lamps	Page 27		Stabilizer Bars, Front & Rear	Page 31
E	Engine Dress-Up Kits	Page 26		Steering Wheels	Page 6
F	Fob & Nobs	Page 9		Steering Wheel Covers	Page 6
	Fog Lamps	Page 27		Stop Watch Holder	Page 20
	Ford Jewelry	Page 12		Stop Watch Strap, Leather	Page 20
G	Gift Sets	Page 9		Suspension Equipment	Page 31
	Gloves	Page 3		Sweatshirts, Cobra	Page 19
	Gloves—Nomex	Page 30		Switches & Panels	Pages 20 & 27
	Goggles	Page 7	T	“T” Bar Shift Knobs	Pages 4 & 5
H	Helmets	Page 8		“T”-Shirts	Page 23
	Hood Pin Kits	Page 16		Tachometer	Pages 21 & 26
J	Jacket Patches	Pages 2 & 19		Texas Chili	Page 32
	Jackets	Pages 18 & 22		Thunderbird Jewelry	Page 12
	Jump Suit	Page 21		Traction Master Kit	Page 31
K	Koni Shocks	Page 31	V	Valve Covers	Page 26
L	Lamp Covers	Page 27		Visors	Page 7
	Lucas Lamps	Page 27	W	Windbreaker	Page 22

Terms and Conditions • Shelby Accessories, Inc. Sales Policies

ORDERING	Always give the catalog page number and full description of material desired. e.g. color, size, style, etc. When ordering accessories for application on a car, please give complete information (e.g. make, model, year, displacement of engine, or type transmission) to avoid errors. Send all orders to: Shelby Accessories, Inc., P. O. Box 747, Plymouth, Michigan 48170.
PAYMENT	Send check or money order payable to Shelby Accessories, Inc. Please do not send cash or stamps. Payment may only be made in United States exchange. We do not accept or process C.O.D. orders. Michigan residents must add 4% sales tax.
FREIGHT AND POSTAGE	Freight or postage will be sent prepaid on all orders within Continental United States. All others will be sent freight or postage collect to the customer.
WARRANTY	All Shelby Accessories, Inc. products are guaranteed against defects in workmanship and/or material. Defective and/or inoperative products will be accepted if returned freight prepaid within 30 days of purchase for inspection and evaluation. Credit will be issued or replacement made on products found defective by Shelby Accessories, Inc.
EXCHANGES	Merchandise may only be exchanged if returned postage prepaid and received in new and saleable condition. Postage charges on exchanges will be charged to the customer.
GENERAL	No person or persons will be permitted to reproduce, use or sell any of the exclusive products, names, or symbols used by Shelby Accessories, Inc. without written consent. Shelby Accessories, Inc. reserves the right to change specifications, withdraw any product, price or offer without notice.



POWER BY 

 **SHELBY**

ACCESSORIES



SHELBY ACCESSORIES, INC., • P.O. BOX 747, PLYMOUTH, MICHIGAN 48170

PRINTED IN U.S.A.